

CNR4

Net Radiometer



Table of contents

1. Introduction	1
2. Precautions	1
3. Initial inspection	1
3.1 Ships with	1
4. QuickStart	2
5. Overview	5
6. Specifications	6
6.1 CNR4 specifications	7
6.2 Pyranometer specifications	8
6.3 Pyrgeometer specifications	9
6.4 Optional CNF4 heater/ventilator	10
6.4.1 CNF4 specifications	10
7. Installation	10
7.1 Siting considerations	11
7.2 Mounting	11
7.3 Wiring	13
7.4 Data logger programming	17
7.4.1 Sensor sensitivity	18
7.4.2 Internal temperature sensors programming	18
8. Operation	19
8.1 Short-wave solar radiation measurements	19
8.2 Long-wave far infrared radiation measurements	20
8.3 Internal temperature sensors measurements	21
8.4 Calculation of albedo	24
8.5 Calculation of net short-wave radiation	24
8.6 Calculation of net long-wave radiation	25
8.7 Calculation of net (total) radiation	25
9. Troubleshooting and maintenance	26
9.1 Troubleshooting	26

9.1.1 Testing the pyranometer	26
9.1.2 Testing the pyrgeometer	27
9.1.3 Testing the thermistor	27
9.1.4 Testing the Pt-100	28
9.2 Maintenance	28
9.2.1 Cleaning windows and domes	28
9.2.2 Replacing the drying cartridge	28
9.3 Recalibration	29
Appendix A. Importing Short Cut code into CRBasic Editor	30
Appendix B. CNR4 performance and measurements under different conditions	31
Appendix C. CNF4 heater ventilator	35
C.1 General information	35
C.2 Attaching the optional CNF4 heater/ventilator unit to CNR4	37
C.3 Wiring	41
C.4 Data logger programming for heater/ventilator control	43
C.5 CNF4 heater/ventilator maintenance	43
C.5.1 Testing the heater	43
C.5.2 Testing the ventilator	43
C.5.3 Replacing the filter for the ventilator	44

1. Introduction

The CNR4 is a research-grade net radiometer that measures the energy balance between incoming and outgoing radiation. Our data loggers measure the CNR4 output. This net radiometer offers a professional solution for scientific-grade energy balance studies.

2. Precautions

- READ AND UNDERSTAND the [Safety](#) section at the back of this manual.
- Although the CNR4 is rugged, it is also a highly precise scientific instrument and should be handled as such.
- Care should be taken when opening the shipping package to not damage or cut the cable jacket. If damage to the cable is suspected, contact Campbell Scientific.
- Do not attempt to rotate the instrument using the sensor heads, or you may damage the sensors; use the mounting rod only.

3. Initial inspection

- Upon receipt of the CNR4, inspect the packaging and contents for damage. File damage claims with the shipping company.
- The model number and cable length are printed on a label at the connection end of the cable. Check this information against the shipping documents to ensure the correct product and cable length are received.
- Refer to the Ships with list to ensure that parts are included (see [Ships with](#) (p. 1)).

3.1 Ships with

(2) Drying Cartridges

(1) WRR Traceable Calibration Certificate for the pyranometers

(1) WRR Traceable Calibration Certificate for the pyregeometers

- (1) Mounting Arm from original manufacturer
- (1) Extra Calibration Stickers from original manufacturer

4. QuickStart

NOTE:

The *Short Cut* example provided here uses the thermistor to provide the temperature correction.

A video that describes data logger programming using *Short Cut* is available at: www.campbellsci.com/videos/cr1000x-datalogger-getting-started-program-part-3 . *Short Cut* is an easy way to program your data logger to measure the sensor and assign data logger wiring terminals. *Short Cut* is available as a download on www.campbellsci.com . It is included in installations of *LoggerNet*, *RTDAQ*, or *PC400*.

The following procedure also describes programming with *Short Cut*.

1. Open *Short Cut* and click **Create New Program**.
2. Double-click the data logger model.
3. In the **Available Sensors and Devices** box, type CNR4 or locate the sensor in the **Sensors > Meteorological > Solar Radiation** folder. Double-click **CNR4 Net Radiometer**. Type the sensitivity values supplied on the manufacturer certificate of calibration; these sensitivity values are unique to each sensor.

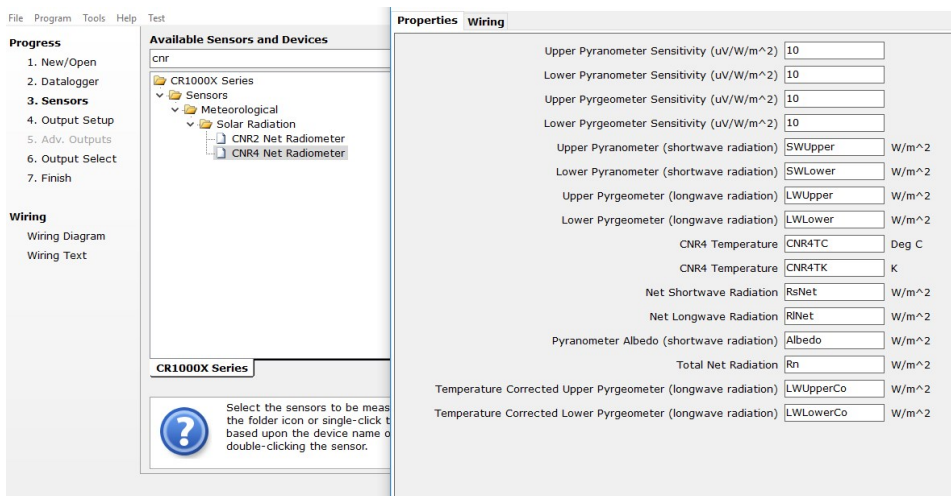

4. Click on the **Wiring** tab to see how the sensor is to be wired to the data logger. Click **OK** after wiring the sensor.

CNR4	CR1000X Series
SOLAR Sig+, Red	1H
SOLAR Sig-, Blue	1L
SOLAR Sig+, White	2H
SOLAR Sig-, Black	2L
SOLAR Sig+, Grey	3H
SOLAR Sig-, Yellow	3L
SOLAR Sig+, Brown	4H
SOLAR Sig-, Green	4L
TEMP Sig, White	5H
TEMP, Black	⏏ (Ground)
TEMP, Clear	⏏ (Ground)
SOLAR, Clear	⏏ (Ground)
TEMP VExc, Red	VX1
	1L
Jumper	⏏ (Ground)
	2L
Jumper	⏏ (Ground)
	3L
Jumper	⏏ (Ground)
	4L
Jumper	⏏ (Ground)

5. Repeat steps three and four for other sensors. Click **Next**.

- In **Output Setup**, enter the scan rate, **Data Output Storage Intervals**, and meaningful table names.

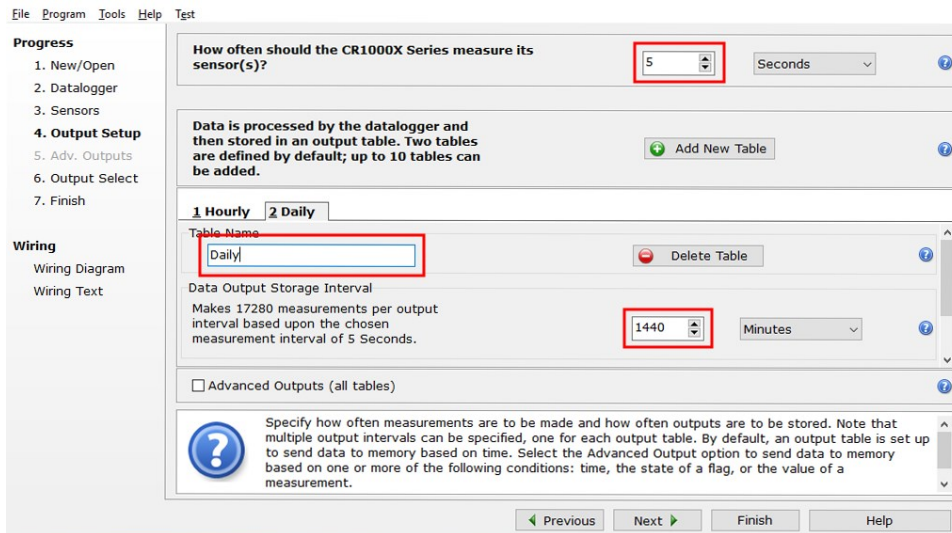

- Select the measurement and its associated output options.

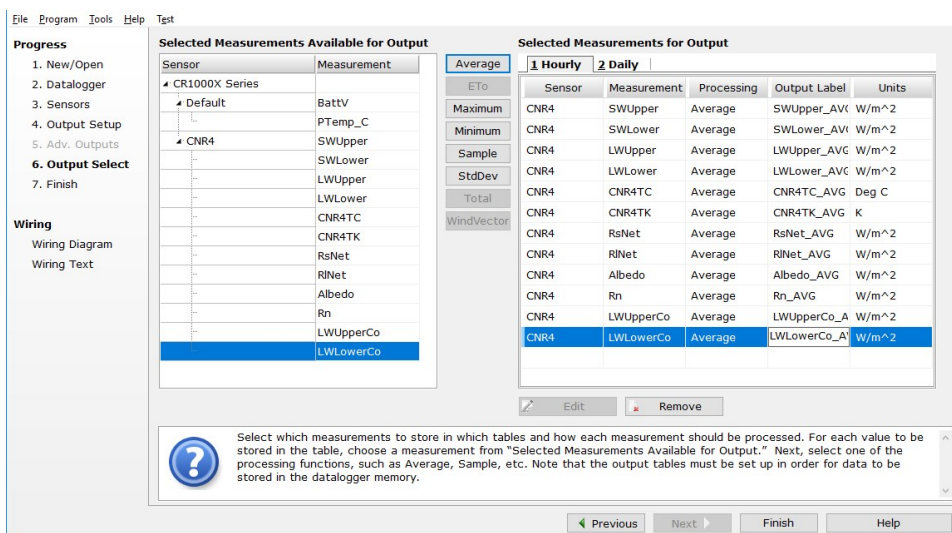

- Click **Finish** and save the program. Send the program to the data logger if the data logger is connected to the computer.
- If the sensor is connected to the data logger, check the output of the sensor in the data logger support software data display in **LoggerNet**, **RTDAQ**, or **PC400** to make sure it is making reasonable measurements.

5. Overview

The CNR4 Net Radiometer consists of a pyranometer pair, one facing upward, the other facing downward, and a pyrgeometer pair in a similar configuration. The pyranometer pair measures short-wave solar radiation, and the pyrgeometer pair measures long-wave far infrared radiation. The upper long-wave detector of CNR4 has a meniscus dome to ensure that water droplets roll off easily while improving the field of view to nearly 180°, compared with a 150° for a flat window. All four sensors are integrated directly into the instrument body, instead of separate modules mounted onto the housing. Each sensor is calibrated individually for optimal accuracy.

Two temperature sensors, a thermistor and a Pt-100, are integrated with the CNR4 body. The temperature sensor is used to provide information to correct the infrared readings for the temperature of the instrument housing. Care has been taken to place the long-wave sensors close to each other and close to the temperature sensors. This ensures that the temperatures of the measurement surfaces are the same and accurately known, improving the quality of the long-wave measurements. A completion resistor is added in the pig tail end of the thermistor cable providing an easy interface with data loggers for half-bridge measurement.

The CNR4 design is light weight and has an integrated solar shield that reduces thermal effects on both the short-wave and the long-wave measurements. The cables are made from Santoprene® jacket, which is intended for outdoor use, and is resistant to a variety of pollutants and UV-radiation. The mounting rod can be unscrewed for transport.

An optional ventilation unit with a heater, CNF4, is designed as an extension of the solar shield and can be fitted to the CNR4 or retrofitted later. The heater/ventilation unit is compact and provides efficient air-flow over the domes and windows to minimize the formation of dew and to reduce the frequency of cleaning. The integrated heater can be used to melt frost.

The CNR4 design is such that both the upward facing and the downward-facing instruments measure the energy that is received from the whole hemisphere (180° field of view). The output is expressed in W/m^2 . The total spectral range that is measured is roughly from 0.3 to 42 μm . This spectral range covers both the short-wave solar radiation, 0.3 to 2.8 μm , and the long-wave far infrared radiation, 4.5 to 42 μm . The gap between these two produces negligible errors.

The CNR4 is manufactured by Kipp & Zonen, but cabled for use with Campbell Scientific data loggers.

Features:

- Research-grade performance
- Meniscus dome on upper long-wave detector allows water droplets to easily roll off of it and increases field of view to nearly 180°
- Internal temperature sensors provide temperature compensation of measurements
- Drying cartridge helps keep the electronics dry
- Compatible with the CNF4 ventilation unit with heater that reduces formation of dew and melts frost
- Separate outputs of short-wave and long-wave infrared radiation for better accuracy and more thorough quality assurance
- Solar shield reduces thermal effects on the sensors
- Compatible with Campbell Scientific CRBasic data loggers: CR6 series, CR3000, CR1000X, and CR1000

6. Specifications

The properties of the CNR4 are mainly determined by the properties of the individual probes. Generally, the accuracy of the CNR4 will be higher than that of competitive net-radiometers, because the solar radiation measurement performed by the pyranometer is accurate, and offers a traceable calibration. Also the optionally integrated heater/ventilator unit improves the accuracy. Due to the fact that the net short-wave radiation can be very intense, 1000 W/m² compared to a typical -100 W/m² net long-wave radiation, the accuracy of the short-wave radiation measurement is critical. Wind corrections, as applied by less accurate competitive instruments are not necessary. The robust materials used imply that the CNR4 will not suffer damages inflicted by birds. [FIGURE 6-1](#) (p. 7) and [FIGURE 6-2](#) (p. 7) show the CNR4 with and without the CNF4 heater/ventilator. From a spectral point of view, the pyranometer and pyrgeometer are complementary, and together they cover the full spectral range.



FIGURE 6-1. The CNR4 net radiometer with cables and mounting rod, top view



FIGURE 6-2. The CNR4 net radiometer with CNF4 heater/ventilator unit, top view

6.1 CNR4 specifications

Sensor sensitivities:	Four probes with unique sensitivity values. Please refer to the calibration sheets or label on the bottom of the sensor for the sensitivity values.
Operating temperature:	-40 to 80 °C (-40 to 176 °F)
Operating humidity:	0 to 100% RH
Bubble level sensitivity:	< 0.5°
Sensor type:	Thermopile
Receiver paint:	Carbon Black
Desiccant:	Silica gel (replaceable)
Housing material:	Anodized aluminum body
Shock/vibration:	IEC 721-3-2-2m2
CE:	Complies with EC guideline 89/336/EEC 73/23/EEC
Environmental protection:	IP 67
Requirements for data acquisition	
Radiation components:	4 differential or 4 single-ended analog terminals
Thermistor:	1 voltage excitation and 1 single-ended analog terminal

Pt-100 temperature:	1 current excitation and 1 differential analog terminal
Cable length:	User defined
Weight	
Sensor:	0.85 kg (1.89 lb) without cables
Heater/ventilator, CNF4 (optional):	0.50 kg (1.11 lb) without cables
Mounting rod:	34.7 cm (13.67 in) length 1.6 cm (0.63 in) diameter

6.2 Pyranometer specifications

Spectral range:	305 to 2800 nm (50% points)
Sensitivity:	10 to 20 $\mu\text{V}/\text{W}/\text{m}^2$
Response time ¹ :	< 18 seconds (95% response)
Non-linearity ¹ :	< 1% (0 to 1000 W m^{-2} irradiance)
Non-stability ¹ :	< 1%
Temperature dependence of sensitivity ¹ :	< 4% (-10 to 40 °C)
Tilt response ¹ :	< 1% at any angle with 1000 W/m^2
Directional error ¹ :	< 20 W/m^2 at angle up to 80° with 1000 W/m^2
Zero offset due to 0 to -200 W/m^2 IR net irradiance ¹ :	< 15 W/m^2
Zero offset due to temperature change ¹ :	< 3 W/m^2 (5 K/hr temperature change) < 1 W/m^2 (with CNF4 installed)
Operating temperature:	-40 to 80 °C
Field of view	
Upper detector:	180°
Lower detector:	150° (due to lower solar shield to prevent illumination at low zenith angles)
Maximum solar irradiance:	2000 W/m^2

Expected accuracy for daily totals:	±10 %
Typical signal output for atmospheric application:	0 to 15 mV
Impedance:	20 to 200 Ω, typically 50 Ω
Detector:	Copper-constantan multi-junction thermopile
Level accuracy:	1 degree
Irradiance:	0 to 2000 W/m ²
Spectral selectivity:	< 3% (330 to 1500 nm spectral interval)
Uncertainty in daily total:	< 5% (95% confidence level)
Instrument calibration:	Indoors. Side by side against reference CMP3 pyranometer according to ISO 9847:1992 annex A.3.1

¹Indicates ISO specifications.

6.3 Pyrgeometer specifications

Spectral range:	4.5 to 42 μm (50% points)
Sensitivity:	5 to 15 μV/W/m ²
Impedance:	20 to 200 Ω (typically 50 Ω)
Response time:	< 18 seconds (95% response)
Non-linearity:	< 1% (-250 to +250 W/m ² irradiance)
Temperature dependence of sensitivity:	< 4% (-10 to 40 °C)
Tilt error:	< 1% (deviation when tilted at any angle off horizontal)
Zero offset due to temperature change:	±4 W/m ² (5 K/hr temperature change)
Field of view	
Upper:	180 degrees
Lower:	150 degrees
Net-irradiance:	-250 to +250 W/m ²
Non-stability:	< 1% (sensitivity change per year)
Window heating offset:	< 6 W/m ² (1000 W/m ² solar irradiance)

Uncertainty in daily total:	< 10% (95% confidence level) indoor calibration
Typical signal output for atmospheric application:	±5 mV
Temperature sensors	
Thermistor:	10 kΩ
Pt-100:	DIN class A
Instrument calibration:	Indoors, side by side against reference CG(R) 3 pyrgeometer. On request outdoors, side by side against reference CG(R) 4 pyrgeometer

6.4 Optional CNF4 heater/ventilator

The purpose of the heater/ventilator is to prevent dew deposition on the pyrgeometer and pyrgeometer window, thus enhancing the measurement accuracy and reliability. Using the heater/ventilator will have negligible effect on the pyranometer reading.

Generally, the errors caused by the heater/ventilator will be small relative to the errors that would have been caused by water deposition.

6.4.1 CNF4 specifications

Heater

Power consumption: 10 W @ 12 VDC (15 Ω)

Ventilator

Power consumption: 5 W @ 12 VDC

Supply voltage: 8 to 13.5 VDC

Weight without cable: 0.5 kg (1.11 lb)

Operating temperature: -40 to 80 °C

7. Installation

If you are programming your data logger with *Short Cut*, skip [Wiring](#) (p. 13) and [Data logger programming](#) (p. 17). *Short Cut* does this work for you. See [QuickStart](#) (p. 2) for a tutorial.

7.1 Siting considerations

1. Mount the sensor so no shadows or reflections will be cast on it at any time of day from obstructions such as trees, buildings, or the mast or structure on which it is mounted. If the instrument is h meters above the surface, 99% of the input of the lower sensors comes from a circular area with a radius of $10h$. Shadows or surface disturbances with a radius $< 0.1h$ will affect the measurement by less than 1%.
2. To avoid shading or reflection effects and to promote spatial averaging, the CNR4 should be mounted at least 1.5 m above the ground or crop surface. It is recommended that the CNR4 be mounted to a separate vertical pipe at least 25 ft from any other mounting structures.
3. The sensor should be mounted with the cable pointing towards the nearest magnetic pole. For example, in the Northern Hemisphere, point the cable toward the North Pole.

7.2 Mounting

A mounting bracket kit is used to mount the CNR4 directly to a vertical pipe, or to a crossarm. Mount the sensor as follows:

1. Attach the mounting rod to the CNR4 (see [FIGURE 7-1](#) (p. 11)).

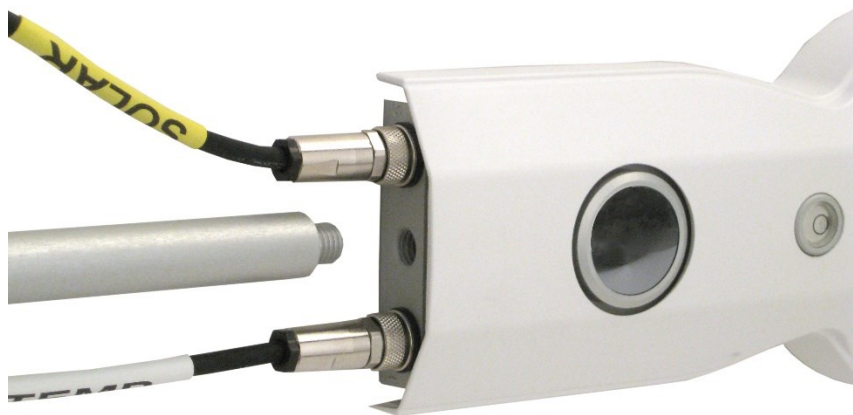

FIGURE 7-1. Attaching the mounting rod to the CNR4 body

2. Attach the 26120 mounting bracket to the vertical mounting pipe, or CM200-series crossarm using the provided U-bolt (see [FIGURE 7-2](#) (p. 12)). If mounted to a vertical pipe, ensure that the pipe does not cast a reflection on the sensor. This includes both the incoming and outgoing sections of the sensor.

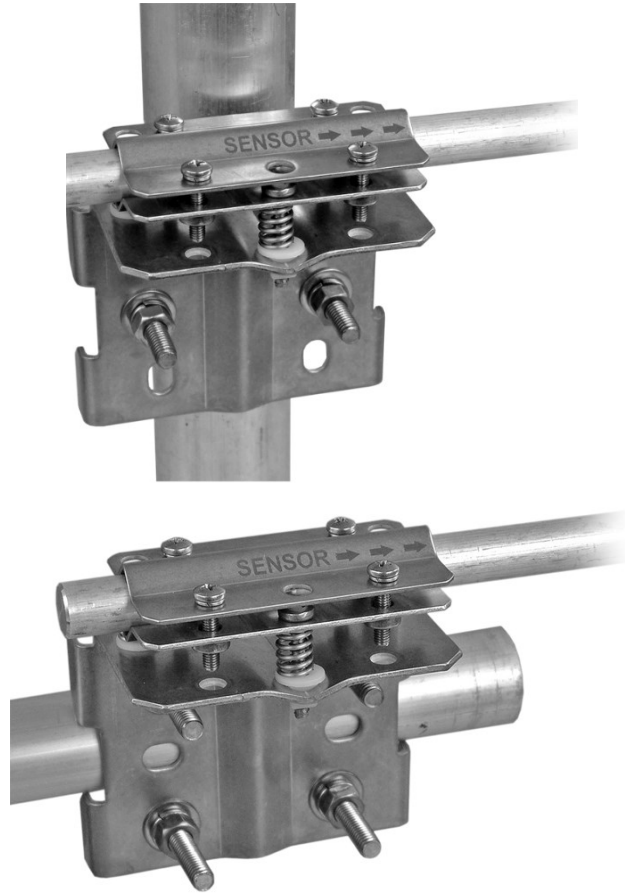

FIGURE 7-2. Attaching the CNR4 onto the mounting rod using vertical pole or horizontal crossarm

3. Insert the sensor support arm into the mounting block of the mounting bracket kit. Make sure the sensor points in the direction of the arrows that appear after the word **SENSOR** on top of the bracket (see [FIGURE 7-2](#) (p. 12)).

NOTE:

If the CNR4 is being used at a location where snow and ice accumulate, or high winds are expected, then the mounting rod should not be fully extended.

CAUTION:

Do not attempt to rotate the instrument using the sensor heads, or you may damage the sensors; use the mounting rod only.

4. Perform a coarse leveling of the sensor using the sensor bubble level.
5. Tighten the four screws on top of the mounting bracket to properly secure the support arm so that it does not rotate (see [FIGURE 7-2](#) (p. 12)).

CAUTION:

The four screws need to be tightened evenly to ensure that the screwhead is in full contact with the V-plate.

6. Perform the fine leveling using the two spring-loaded leveling screws—one on the front and the other on the back of the bracket.
7. Route the sensor cable to the instrument enclosure.
8. Use the UV-resistant cable ties included with the tripod or tower to secure the cable to the vertical pipe or crossarm and tripod/tower.

7.3 Wiring

NOTE:

This manual provides wiring information for CNR4 sensors and cables purchased from Campbell Scientific. Sensors and cables purchased directly from Kipp and Zonen will have different wiring.

The CNR4 has two outputs for short-wave radiation, two outputs for long-wave radiation, thermistor output, and Pt-100 temperature sensor output. The optional CNF4 heater/ventilator unit has power wires for heater and ventilator and a control/pulse wire for the tachometer.

The CNR4 has a SOLAR cable and a TEMP cable ([FIGURE 7-3](#) (p. 14)). Connect the SOLAR cable to the **S** port and the TEMP cable to the **T** port ([FIGURE 7-4](#) (p. 14)). The two cables, SOLAR and

TEMP, have identical connectors, and therefore ensure that the correct cables are connected to the correct ports of the sensor.



FIGURE 7-3. The CNR4 sensor with SOLAR and TEMP cables



FIGURE 7-4. The marks on the end of the CNR4: S for SOLAR cable, and T for TEMP cable

The four radiation outputs can be measured using differential or single-ended inputs on the data logger. A differential voltage measurement is recommended because it has better noise rejection than a single-ended measurement. If differential terminals are not available, single-ended measurements can be used. The acceptability of a single-ended measurement can be determined by comparing the results of single-ended and differential measurements made under the same conditions.

NOTE:

When differential inputs are used, jumper the low side of the input to \perp to keep the signal in common mode range.

Table 7-1 (p. 15) shows the data logger connections for the **SOLAR** cable, and Table 7-2 (p. 16) shows the data logger connections for the **TEMP** cable. The cables have the white band at the pigtail end of the cable with the color keys (FIGURE 7-5 (p. 15), FIGURE 7-6 (p. 17)).



FIGURE 7-5. Labels on the pigtail end of the SOLAR cable

Table 7-1: SOLAR cable (wire color, function, and data logger connection)			
Wire color	Wire function	Differential data logger connection terminal	Single-ended data logger connection terminal
Red	Pyranometer top signal	U configured for differential high analog input ¹ , DIFF H (differential high, analog-voltage input)	U configured for single-ended analog input ¹ , SE (single-ended, analog-voltage input)
Blue	Pyranometer top reference	U configured for differential low analog input ^{1, 2} , DIFF L (differential low, analog-voltage input) ²	⏏ (analog ground)
White	Pyranometer bottom signal	U configured for differential high analog input ¹ , DIFF H (differential high, analog-voltage input)	U configured for single-ended analog input ¹ , SE (single-ended, analog-voltage input)
Black	Pyranometer bottom reference	U configured for differential low analog input ^{1, 2} , DIFF L (differential low, analog-voltage input) ²	⏏ (analog ground)
Grey	Pyrgeometer top signal	U configured for differential high analog input ¹ , DIFF H (differential high, analog-voltage input)	U configured for single-ended analog input ¹ , SE (single-ended, analog-voltage input)
Yellow	Pyrgeometer top reference	U configured for differential low analog input ^{1, 2} , DIFF L (differential low, analog-voltage input) ²	⏏ (analog ground)

Table 7-1: SOLAR cable (wire color, function, and data logger connection)

Wire color	Wire function	Differential data logger connection terminal	Single-ended data logger connection terminal
Brown	Pyrgometer bottom signal	U configured for differential high analog input ¹ , DIFF H (differential high, analog-voltage input)	U configured for single-ended analog input ¹ , SE (single-ended, analog-voltage input)
Green	Pyrgometer bottom reference	U configured for differential low analog input ^{1, 2} , DIFF L (differential low, analog-voltage input) ²	⚡ (analog ground)
Clear	Shield	⚡ (analog ground)	⚡ (analog ground)

¹U terminals are automatically configured by the measurement instruction.

²Jumper to ⚡ with a user-supplied wire.

Table 7-2: TEMP cable (wire color, function, and data logger connection)

Wire color	Wire function	Data logger connection terminal	
		Using thermistor ¹	Using Pt-100 ¹
White	Thermistor signal	U configured for single-ended analog input ² , SE (single-ended, analog-voltage input)	N/A
Red	Thermistor voltage excitation	U configured for voltage excitation ² , EX, VX (voltage excitation)	N/A
Black	Thermistor reference	⚡ (analog ground)	N/A
Green	PRT (Pt-100) signal	N/A	U configured for differential high analog input ² , DIFF H (differential high, analog-voltage input)
Yellow	PRT (Pt-100) signal reference	N/A	U configured for differential low analog input ² , DIFF L (differential low, analog-voltage input)

Table 7-2: TEMP cable (wire color, function, and data logger connection)

Wire color	Wire function	Data logger connection terminal	
		Using thermistor ¹	Using Pt-1001
Grey	PRT (Pt-100) current excitation	N/A	U configured for current excitation ² , IX (current excitation)
Brown	PRT (Pt-100) current return	N/A	IXR (current excitation return), \perp (CR6 only)
Clear	Shield	\perp (analog ground)	\perp (analog ground)

¹Pull back unused wires and tie them around the TEMP cable using a cable tie or electrical tape to avoid possible damage to the thermistor or Pt-100, due to electrical short circuit.

²U terminals are automatically configured by the measurement instruction.



FIGURE 7-6. Labels on the pigtail end of the TEMP cable

7.4 Data logger programming

Short Cut is the best source for up-to-date programming code for Campbell Scientific data loggers. If your data acquisition requirements are simple, you can probably create and maintain a data logger program exclusively with **Short Cut**. If your data acquisition needs are more complex, the files that **Short Cut** creates are a great source for programming code to start a new program or add to an existing custom program.

NOTE:

Short Cut cannot edit programs after they are imported and edited in **CRBasic Editor**.

A *Short Cut* tutorial is available in [QuickStart](#) (p. 2). If you wish to import *Short Cut* code into *CRBasic Editor* to create or add to a customized program, follow the procedure in [Importing Short Cut code into CRBasic Editor](#) (p. 30). Programming basics for CRBasic data loggers are provided in the following sections.

Complete downloadable program examples are available at:

www.campbellsci.com/downloads/cnr4-thermistor-example-program 

www.campbellsci.com/downloads/cnr4-pt100-example-program 

www.campbellsci.com/downloads/cnr4-cnf4-example-program 

The CNR4 outputs four voltages that are measured with the [VolTDiff\(\)](#) or [VolTSE\(\)](#) CRBasic instructions. The voltage outputs typically range from 0 to 15 mV for the pyranometers, and ± 5 mV for the pyrgeometers.

7.4.1 Sensor sensitivity

The CNR4 comes with four different sensor sensitivity values for four separate probes. The CNR4 sensor comes with two copies of its 'Certificate of Calibration' by the manufacturer. They show the sensor serial number and sensitivity values for four individual probes: one copy for pyranometers, and another copy for pyrgeometers. The serial number and sensitivity values are also shown on a label affixed to the bottom of the sensor. If you choose to attach the CNF4 heater/ventilator unit to the CNR4, the label showing the serial number and sensitivity values will be covered. After attaching the CNF4 heater/ventilator, affix the extra label to the bottom of the CNF4 in a visible location. The extra label containing the serial number and sensitivity values is supplied with the purchase of the CNR4. Please refer to [CNF4 heater ventilator](#) (p. 35) for more details.

The sensor sensitivity is in $\mu\text{V}/(\text{W}/\text{m}^2)$. This needs to be converted into $(\text{W}/\text{m}^2)/\text{mV}$ to be used as a multiplier parameter inside the data logger program. To convert the units, divide the sensor sensitivity value into 1000. For example, if the sensitivity is $7.30 \mu\text{V}/(\text{W}/\text{m}^2)$, the multiplier is $1000/7.3 = 136.99 (\text{W}/\text{m}^2)/\text{mV}$.

7.4.2 Internal temperature sensors programming

The thermistor is typically used with Campbell Scientific data loggers. The thermistor is measured using the [BrHalf\(\)](#) CRBasic instruction. The value provided by the half bridge instruction needs to be converted to resistance and then converted to temperature.

Use the following expression in the program to convert to resistance:

$$R_s = R_f \cdot (V_s - V_x) / (1 - V_s - V_x)$$

Where,

Rf = fixed resistance in ohms (Rf is 1000)

Vs_Vx = value returned by the **BrHalf()** instruction

The Steinhart-Hart equation is used to convert resistance to temperature. The Steinhart-Hart equation for converting resistance to degree Celsius is as follows:

$$\text{Temperature} = 1(1.0295e-3 + 2.391e-4 \times \text{LN}(R_s) + 1.568e-7 \times (\text{LN}(R_s))^3) - 273.15$$

In CRBasic, the Steinhart-Hart equation is entered as a mathematical expression. A downloadable example program that uses a thermistor is available at: www.campbellsci.com/downloads/cnr4-thermistor-example-program .

The Pt-100 is measured with the **Resistance()** CRBasic instruction. The value provided by the **Resistance()** instruction needs to be divided by 100 then converted to temperature using the **PRTCalc()** instruction. A downloadable program that uses the Pt-100 is available at: www.campbellsci.com/downloads/cnr4-pt100-example-program .

Details about the internal sensors are provided in [Internal temperature sensors measurements](#) (p. 21).

8. Operation

In the four separate components mode configuration (measuring two short-wave radiation signals and two long-wave signals), all signals are measured separately. Calculation of net-radiation and albedo can be done online by the data logger, or offline by the user during post-processing, using the stored raw data.

The two pyranometers will measure the short-wave radiation, both incoming and reflected. The two pyrgeometers will measure the long-wave radiation. For proper analysis of the pyrgeometer measurement results, they must be temperature corrected using the temperature measurement performed by the onboard thermistor or Pt-100 sensor.

8.1 Short-wave solar radiation measurements

The pyranometer generates a millivolt signal that is simply proportional to the incoming short-wave radiation. The conversion factor between voltage, V, and W/m² of solar irradiance E, is the calibration constant C or sensitivity ([Eq. 1](#) (p. 20)).

For each pyranometer,

$$E = V/C$$

Eq. 1

Incidental light results in a positive signal. The pyranometer mounting plate and ambient air should be at the same temperature. Conversion of the voltage to irradiance can be done according to [Eq. 1](#) (p. 20), and is computed by the data logger program.

With the upward-facing pyranometer, the global (solar) downwelling radiation is measured. The downward-facing pyranometer measures the reflected upwelling solar radiation. When calculating the net radiation, the upwelling radiation must be subtracted from the downwelling radiation. See [Calculation of net short-wave radiation](#) (p. 24).

8.2 Long-wave far infrared radiation measurements

The signal generated by the pyrgeometer represents the exchange of long-wave far infrared (thermal) radiation between the pyrgeometer and the object that it is facing. This implies that the pyrgeometer will generate a positive voltage output, V , when it faces an object that is hotter than its own sensor housing, and a negative voltage signal when it faces an object that is colder. Therefore, when estimating the far infrared radiation that is generated by the object facing the pyrgeometer, usually the sky or the soil, you will have to take the pyrgeometer temperature, T , into account. This is why the temperature sensors are incorporated in the CNR4 body near the pyrgeometer sensing element, and has, therefore, the same temperature as the pyrgeometer sensor surface. The calculation of the long-wave far infrared irradiance, E , is done according to [Eq. 2](#) (p. 20).

For the pyrgeometer only

$$E = V/C + 5.67 \times 10^{-8} \times T^4$$

Eq. 2

In this equation, C is the sensitivity of the sensor.

NOTE:

T is in Kelvin, and not in Celsius or Fahrenheit.

The downward-facing pyrgeometer measures the far infrared radiation that is emitted by the ground. The upward-facing pyrgeometer measures the far infrared radiation from the sky. As the sky is typically colder than the instrument, one can expect negative voltage signals from the upward-facing pyrgeometer. [Eq. 2](#) (p. 20) is used to calculate the far infrared irradiance of the sky and of the ground.

8.3 Internal temperature sensors measurements

The CNR4 has two temperature sensors built inside: thermistor and Pt-100; both have identical accuracy. The thermistor is recommended when using Campbell Scientific data loggers. The thermistor has a greater resistance (10 kΩ at 25 °C) than Pt-100 sensor (100 Ω at 0 °C), and the change in resistance with respect to temperature, in absolute terms, is greater. Therefore, the cable resistance can be neglected, and the thermistor can easily be measured using Half-Bridge Measurement instruction on Campbell Scientific data loggers.

Table 8-1 (p. 21) shows the thermistor resistance values as a function of temperature.

Temperature [°C]	Resistance [Ω]	Temperature [°C]	Resistance [Ω]	Temperature [°C]	Resistance [Ω]
-30	135200	0	29490	30	8194
-29	127900	1	28150	31	7880
-28	121100	2	26890	32	7579
-27	114600	3	25690	33	7291
-26	108600	4	24550	34	7016
-25	102900	5	23460	35	6752
-24	97490	6	22430	36	6500
-23	92430	7	21450	37	6258
-22	87660	8	20520	38	6026
-21	83160	9	19630	39	5805
-20	78910	10	18790	40	5592
-19	74910	11	17980	41	5389
-18	71130	12	17220	42	5193
-17	67570	13	16490	43	5006
-16	64200	14	15790	44	4827
-15	61020	15	15130	45	4655
-14	58010	16	14500	46	4489
-13	55170	17	13900	47	4331

Table 8-1: Resistance values versus CNR4 thermistor temperature in °C

Temperature [°C]	Resistance [W]	Temperature [°C]	Resistance [W]	Temperature [°C]	Resistance [W]
-12	52480	18	13330	48	4179
-11	49940	19	12790	49	4033
-10	47540	20	12260	50	3893
-9	45270	21	11770	51	3758
-8	43110	22	11290	52	3629
-7	41070	23	10840	53	3504
-6	39140	24	10410	54	3385
-5	37310	25	10000	55	3270
-4	35570	26	9605	56	3160
-3	33930	27	9227	57	3054
-2	32370	28	8867	58	2952
-1	30890	29	8523	59	2854

Relatively small errors occur when the CNR4 is not in thermal equilibrium. This happens for example when the heater is on, or when the sun is shining. When the heater and ventilator are on, the largest expected deviation between the real sensor temperature and the thermistor reading is 1 degree. This results in a worst case error for the pyrgometer of 5 W/m². When the sun is shining, the largest expected deviation between the real sensor temperature and the thermistor reading is again 1 degree. This results in a worst case error for the pyrgometer of 5 W/m².

The thermistor will not give a good indication of ambient air temperature; at 1000 W/m² solar radiation, and no wind, the instrument temperature will rise approximately 5 degrees above the ambient temperature.

The offsets of both the pyranometers and the pyrgometers might be larger than 5 W/m² if large temperature gradients are forced on the instrument (larger than 5 K/hr); for example, when rain hits the instrument. This occurrence can be detected using the thermistor readout, and can be used for data filtering.

Alternatively, you can use the Pt-100 to make the temperature measurement. The Pt-100 requires one current excitation terminal, and one differential analog terminal. The CR6 and CR3000 have current excitation terminals. [Table 8-2](#) (p. 23) shows the Pt-100 resistance values as a function of temperature.

Table 8-2: Resistance values versus CNR4 Pt-100 temperature in °C

Temperature [°C]	Resistance [W]	Temperature [°C]	Resistance [W]	Temperature [°C]	Resistance [W]
-30	88.22	0	100.00	30	111.67
-29	88.62	1	100.39	31	112.06
-28	89.01	2	100.78	32	112.45
-27	89.40	3	101.17	33	112.83
-26	89.80	4	101.56	34	113.22
-25	90.19	5	101.95	35	113.61
-24	90.59	6	102.34	36	113.99
-23	90.98	7	102.73	37	114.38
-22	91.37	8	103.12	38	114.77
-21	91.77	9	103.51	39	115.15
-20	92.16	10	103.90	40	115.54
-19	92.55	11	104.29	41	115.93
-18	92.95	12	104.68	42	116.31
-17	93.34	13	105.07	43	116.70
-16	93.73	14	105.46	44	117.08
-15	94.12	15	105.85	45	117.47
-14	94.52	16	106.24	46	117.85
-13	94.91	17	106.63	47	118.24
-12	95.30	18	107.02	48	118.62
-11	95.69	19	107.40	49	119.01
-10	96.09	20	107.79	50	119.40
-9	96.48	21	108.18	51	119.78
-8	96.87	22	108.57	52	120.16
-7	97.26	23	108.96	53	120.55
-6	97.65	24	109.35	54	120.93
-5	98.04	25	109.73	55	121.32

Table 8-2: Resistance values versus CNR4 Pt-100 temperature in °C

Temperature [°C]	Resistance [W]	Temperature [°C]	Resistance [W]	Temperature [°C]	Resistance [W]
-4	98.44	26	110.12	56	121.70
-3	98.83	27	110.51	57	122.09
-2	99.22	28	110.90	58	122.47
-1	99.61	29	111.28	59	122.86

8.4 Calculation of albedo

Albedo is the ratio of reflected short-wave radiation to incoming short-wave radiation. This unitless value ranges between 0 and 1. Typical values are 0.9 for snow, and 0.3 for grassland. To determine the albedo, the measured values of the two pyranometers are used. Do not use the measured values when the solar elevation is lower than 10 degrees above the horizon. Errors in the measurements at these elevations are likely and yield unreliable results. This is due to deviations in the directional response of the pyranometers.

$$\text{Albedo} = (\text{E lower Pyranometer}) / (\text{E upper Pyranometer}) \quad \text{Eq. 3}$$

In [Eq. 3](#) (p. 24), E is calculated according to the [Eq. 1](#) (p. 20).

Albedo will always be smaller than 1. Checking this can be used as a tool for quality assurance of your data. If you know the approximate albedo at your site, the calculation of albedo can also serve as a tool for quality control of your measured data at a specific site.

8.5 Calculation of net short-wave radiation

The net short-wave solar radiation is equal to the incoming (downwelling) short-wave radiation minus the reflected (upwelling) short-wave radiation.

$$\begin{aligned} \text{Net Short-wave Radiation} = & (\text{E upper Pyranometer}) \\ & - (\text{E lower Pyranometer}) \end{aligned} \quad \text{Eq. 4}$$

In [Eq. 4](#) (p. 24), E is calculated according to [Eq. 1](#) (p. 20).

Net short-wave solar radiation will always be positive. This can be used as a tool for quality assurance of your measured data.

8.6 Calculation of net long-wave radiation

The net long-wave far infrared radiation is the part that contributes to heating or cooling of the earth's surface. In practice, usually the net long-wave far infrared radiation will be negative.

$$\begin{aligned} \text{Net Long-wave Radiation} &= (\text{E upper Pyrgeometer}) \\ &\quad - (\text{E lower Pyrgeometer}) \end{aligned} \tag{Eq. 5}$$

In Eq. 5 (p. 25), E is calculated according to Eq. 2 (p. 20). According to Eq. 5 (p. 25), the terms that contain the sensor body temperature, T, cancel each other. Therefore, if only interested in the net long-wave radiation, instead of separate upper and lower components of the long-wave radiation, the CNR4 temperature measurement is not required.

The E measured with the pyrgeometer actually represents the irradiance of the sky (for upward-facing pyrgeometer) or the ground (for downward-facing pyrgeometer). Assuming that these two, ground and sky, behave like perfect blackbodies, theoretically, one can calculate an effective sky temperature and an effective ground temperature.

$$\text{Sky Temperature} = \left[\frac{\text{E upper Pyrgeometer}}{5.67 \cdot 10^{-8}} \right]^{1/4} \tag{Eq. 6}$$

$$\text{Ground Temperature} = \left[\frac{\text{E lower Pyrgeometer}}{5.67 \cdot 10^{-8}} \right]^{1/4} \tag{7}$$

As a rule of thumb, for ambient temperatures of about 20 degrees Celsius, one can say that one degree of temperature difference between two objects results in a 5 W/m² exchange of radiative energy (infinite objects):

1 degree of temperature difference = 5 W/m² (rule of thumb)

8.7 Calculation of net (total) radiation

In the four separate components mode, net radiation, R_n, can be calculated using the individual sensor measurement results:

$$\begin{aligned} R_n &= [(E \text{ upper Pyranometer}) - (E \text{ lower Pyranometer})] \\ &\quad + [(E \text{ upper Pyrgeometer}) - (E \text{ lower Pyrgeometer})] \end{aligned} \tag{Eq. 8}$$

Where E upper/lower pyranometers are calculated according to Eq. 1 (p. 20), and E upper/lower pyrgeometers are calculated according to Eq. 2 (p. 20). The terms with T cancel each other out.

9. Troubleshooting and maintenance

NOTE:

For all factory repairs, customers must get an RMA number. Customers must also properly fill out a "Declaration of Hazardous Material and Decontamination" form and comply with the requirements specified in it. Refer to the [Assistance](#) page at the back of this manual for more information.

9.1 Troubleshooting

If there is no indication as to what may be the problem, start performing the following "upside-down test", which is a rough test for a first diagnosis. It can be performed both outdoors and indoors. Indoors, a lamp can be used as a source for both short-wave and long-wave radiation. Outdoors, one should preferably work with a solar elevation of more than 45 degrees (45 degrees above horizon) and under stable conditions (no large changes in solar irradiance, and preferably no clouds).

1. Measure the radiation outputs in the normal position. Record the measured values when the signals have stabilized, i.e. after about three minutes.
2. Rotate the instrument 180 degrees, so that the upper and the lower sensors are now in the reverse orientation as to the previous position.
3. Measure the radiation outputs once more. Record the measured values when the radiometers have stabilized.
4. The computed net radiation values in rotated position should be equal in magnitude but only differing in sign. In a rough test like this, deviations of $\pm 10\%$ can be tolerated. If deviations greater than this are encountered, additional testing is warranted.

9.1.1 Testing the pyranometer

As a first test, check the sensor impedance. It should have a nominal value as indicated in the specifications. Zero, or infinite resistance, indicates a failure in hardware connection.

Before starting the second test measurement, let the pyranometer rest for at least five minutes to let it regain its thermal equilibrium. For testing, set a voltmeter to its most sensitive range setting. Darken the sensor. The signal should read zero; this response can take up to one minute. Small

deviations from zero are possible; this is caused by the thermal effects, such as touching the pyranometer with your hand. This thermal effect can be demonstrated by deliberately heating the pyranometer with your hand. If the zero offset is within specifications, proceed with the third test.

In the third test, the sensor should be exposed to light. The signal should be a positive reading. Set the voltmeter range in such a way that the expected full-scale output of the pyranometer is within the full-scale input range of the voltmeter. The range can be estimated on theoretical considerations. When the maximum expected radiation is 1500 W/m^2 , which is roughly equal to normal outdoor daylight conditions, and the sensitivity of the pyranometer is $15 \text{ } \mu\text{V per W/m}^2$, the expected output range of the pyranometer is equal to $22500 \text{ } \mu\text{V}$, or 22.5 mV . One can calculate the radiation intensity by dividing the pyranometer output as measured by the voltmeter (for example, 22.5 mV) by the sensor sensitivity ($15 \text{ } \mu\text{V/W/m}^2$). If no faults are found up to this point, your pyranometer is probably operating correctly.

9.1.2 Testing the pyrgeometer

The zero offset is assumed to be no more than a few watts per square meter (see second test in [Testing the pyranometer](#) (p. 26)).

The CNR4 body and the ambient air should be at the same temperature. Let the pyrgeometer rest for at least five minutes to regain its thermal equilibrium. Set the voltmeter to its most sensitive range. To test if the pyrgeometer is working properly, put your hand in front of the pyrgeometer. The thermal radiation from your hand will cause the pyrgeometer to generate a positive voltage when the surface temperature of your hand is higher than the pyrgeometer temperature. The pyrgeometer will generate a negative voltage if the hand is colder. The signal is proportional to the temperature difference (see the rule of thumb in [Calculation of net long-wave radiation](#) (p. 25)). The radiation emitted by the hand can be calculated by dividing the pyrgeometer output by the sensor sensitivity value, and subsequently correcting for the temperature, according to [Eq. 2](#) (p. 20). If there are still no faults found, your pyrgeometer is probably operating correctly.

9.1.3 Testing the thermistor

Use a multimeter to measure the resistance between the black and white wires of the thermistor, and compare the value with the resistance values listed in [Table 8-1](#) (p. 21). The resistance should be around $10 \text{ k } \Omega$ at $25 \text{ } ^\circ\text{C}$, and the cable resistance should add about $0.026 \text{ } \Omega$ per each foot of cable. When in doubt, the Pt-100 resistance (temperature) can be checked as well for reference.

9.1.4 Testing the Pt-100

Use a multimeter to measure the resistance between the two opposite wires of the Pt-100 (gray-yellow, gray-brown, green-yellow, green-brown), and compare the measured value with the resistance values listed in [Table 8-2](#) (p. 23). The resistance should be above 100 Ω at 0 °C, and the cable resistance should add about 0.026 Ω per each foot of cable. When in doubt, the thermistor resistance (temperature) can be checked as well for reference.

9.2 Maintenance

The CNR4 is weatherproof and intended for continuous outdoor use. The materials used in the pyranometer and the pyrgeometer are robust and require little maintenance. For optimal results, however, proper care must be taken.

9.2.1 Cleaning windows and domes

Dirty domes and windows can reduce the radiometer readings. The site operator should check the windows and domes of the CNR4 regularly, and clean them as needed. Use distilled water or alcohol as cleaning solution, being careful not to scratch the windows and domes during cleaning.

9.2.2 Replacing the drying cartridge

The CNR4 has a drying cartridge inside the sensor to help keep the electronics dry. The manufacturer recommends replacing the drying cartridge every 6 to 12 months. The three screws holding the white solar shield and the six screws holding the aluminium base plate need to be removed to access the drying cartridge, as shown in [FIGURE 9-1](#) (p. 29). Make sure that the black rubber gasket is put in place properly before the base plate is put back to keep the compartment sealed. The CNR4 comes with two spare drying cartridges. Additional drying cartridges can be purchased from Campbell Scientific.

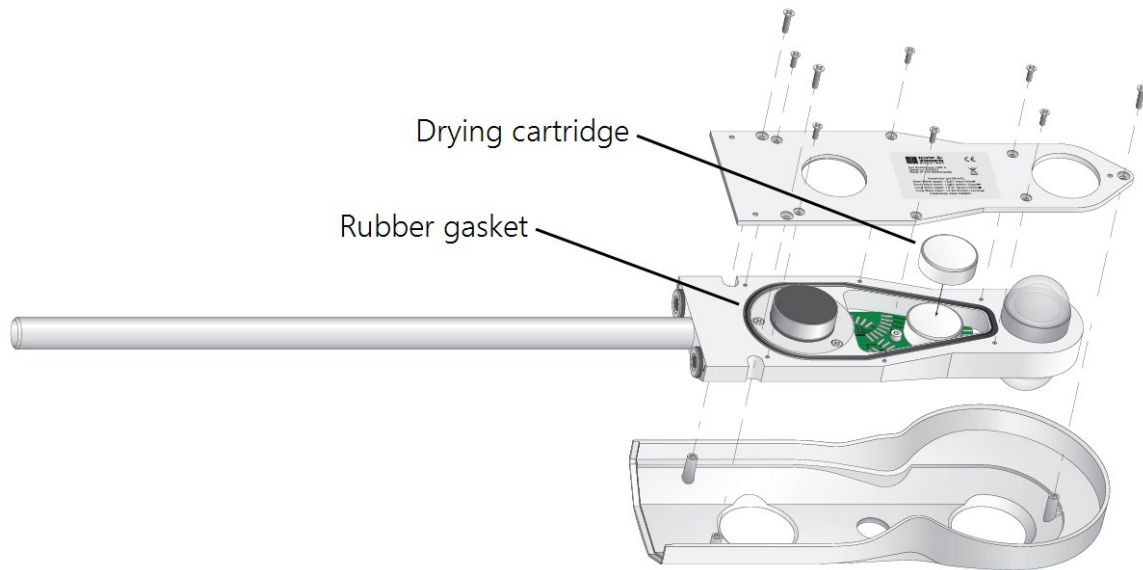

FIGURE 9-1. Replacing the drying cartridge

9.3 Recalibration

For quality assurance of the measured data, the manufacturer recommends the CNR4 be recalibrated on a regular schedule by an authorized Kipp & Zonen calibration facility.

The CNR4 should be recalibrated every two years. Alternatively, one can check the sensor calibration by letting a higher standard run parallel to it over a two-day period and, then, comparing the results. For comparison of pyranometers, one should use a clear day. For comparison of pyrgeometers, one should compare the nighttime results. If the deviations are greater than 6%, the sensor should be recalibrated.

Appendix A. Importing *Short Cut* code into *CRBasic Editor*

Short Cut creates a .DEF file that contains wiring information and a program file that can be imported into the *CRBasic Editor*. By default, these files reside in the C:\campbellsci\SCWin folder.

Import *Short Cut* program file and wiring information into *CRBasic Editor*:

1. Create the *Short Cut* program. After saving the *Short Cut* program, click the **Advanced** tab then the **CRBasic Editor** button. A program file with a generic name will open in CRBasic. Provide a meaningful name and save the CRBasic program. This program can now be edited for additional refinement.

NOTE:

Once the file is edited with *CRBasic Editor*, *Short Cut* can no longer be used to edit the program it created.

2. To add the *Short Cut* wiring information into the new CRBasic program, open the .DEF file located in the C:\campbellsci\SCWin folder, and copy the wiring information, which is at the beginning of the .DEF file.
3. Go into the CRBasic program and paste the wiring information into it.
4. In the CRBasic program, highlight the wiring information, right-click, and select **Comment Block**. This adds an apostrophe (') to the beginning of each of the highlighted lines, which instructs the data logger compiler to ignore those lines when compiling. The **Comment Block** feature is demonstrated at about 5:10 in the [CRBasic | Features](#) video .

Appendix B. CNR4 performance and measurements under different conditions

Table B-1 (p. 31) shows what one might typically expect to measure under different meteorological conditions.

The first parameter is day and night. At night, the solar radiation is zero. The second column shows if it is cloudy or clear. A cloud acts like a blanket, absorbing part of the solar radiation, and keeping net far infrared radiation close to zero. The third parameter is ambient temperature; this is included to show that the sky temperature, column nine, "sky T", tracks the ambient temperature. Under cloudy conditions this is logical; cloud bases will be colder than the ambient temperature. At instrument level, the temperature difference depends roughly on cloud altitude.

Under clear sky conditions, it is less obvious that sky temperature "adjusts" to the ambient temperature. This can roughly be attributed to the water vapor in the air, which is a major contributor to the far infrared radiation.

Table B-1: Typical output signals of CNR4 under different meteorological conditions. Explanation can be found in the text.									
1	2	3	4	5	6	7	8	9	10
Day night	Cloudy clear	+20°C -20°C	Pyrgeo- meter up	Pyrgeo- meter low	Pyrano- meter up	Pyrano- meter low	Pt 100	sky T	ground T
d	cloud	+20	0	0	0-500	0-150	20	20	20
d	cloud	-20	0	0	0-500	0-150	-20	-20	-20
d	clear	+20	-100 ¹	0	0-1300	0-400	20	1 ¹	20
d	clear	-20	-100 ¹	0	0-1300	0-400	-20	-53 ¹	-20
n	cloud	+20	0	0	0	0	20	20	20
n	cloud	-20	0	0	0	0	-20	-20	-20

Table B-1: Typical output signals of CNR4 under different meteorological conditions.
 Explanation can be found in the text.

1	2	3	4	5	6	7	8	9	10
n	clear	+20	-100 ³	0	0 ²	0	20	1 ³	20
n	clear	-20	-100 ³	0	0 ²	0	-20	-53 ³	-20

¹Values may suffer from the so-called window heating offset; the sun heats the pyrgeometer window causing a measurement error of +10 Watts per square meter (maximum).

²Values may suffer from negative infrared offsets, caused by cooling off of the pyranometer dome by far infrared radiation. The maximum expected offset value is 15 Watts per square meter.

³Values may suffer from dew deposition. This causes the pyrgeometer-up values to rise from -100 to 0 Watts per square meter.



Values calculated using: Werte, errechnet aus Formel: Calcul des valeurs à l'aide: Utilizar valores calculados:			
$E = \frac{U_{emf}}{S}$	Fully clouded Bewölkt Très nuageux Totalmente Nublado	Sunny, partly clouded Sonnig, teils bewölkt Ensoleillé, un peu nuageux Parcialmente nublado	Clear and Sunny Klarer Himmel und sonnig Clair et ensoleillé Cielo despejado
Pyranometer			
Upper Oben • Supérieur • Superior	50 ... 120 W/m ²	120 ... 500 W/m ²	500 ... 1000 W/m ²
Lower Unten • Inférieur • Más bajo	0 ... 50 W/m ²	50 ... 200 W/m ²	200 ... 400 W/m ²
Pyrgeometer			
Upper Oben • Supérieur • Superior	0 ... -10 W/m ²	-10 ... -50 W/m ²	-50 ... -150 W/m ²
Lower Unten • Inférieur • Más bajo	-25 ... 25 W/m ²	-25 ... 25 W/m ²	-25 ... 25 W/m ²

FIGURE B-1. Different measurement conditions and signals

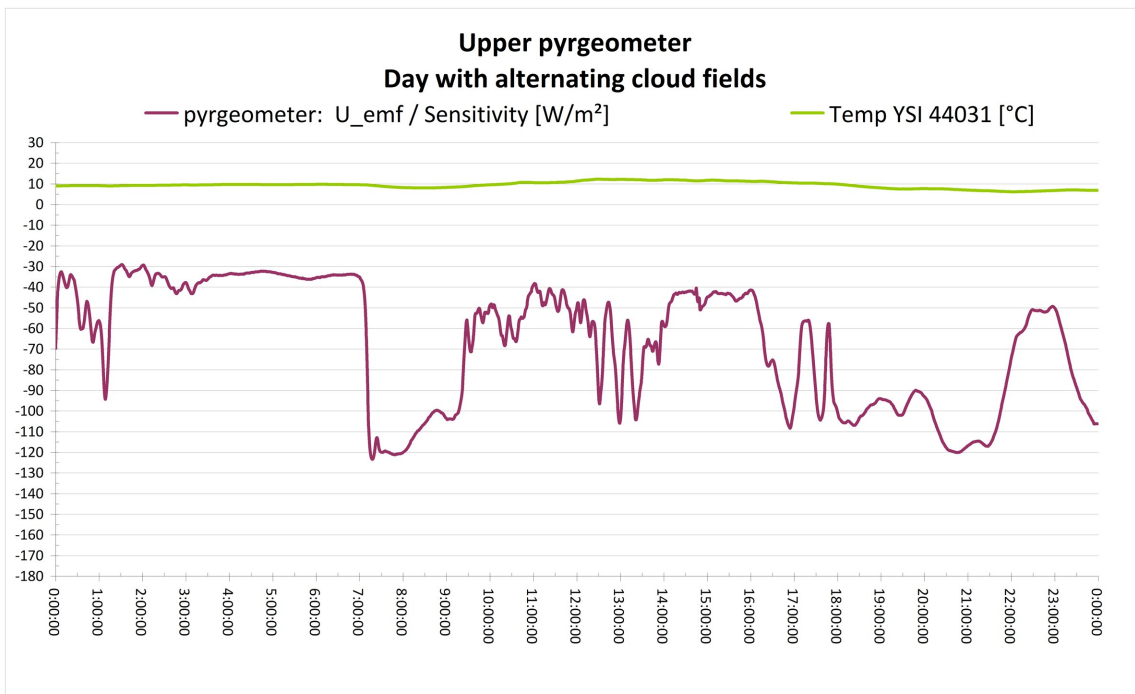

FIGURE B-2. Partly cloudy day for the upward facing pyrgometer

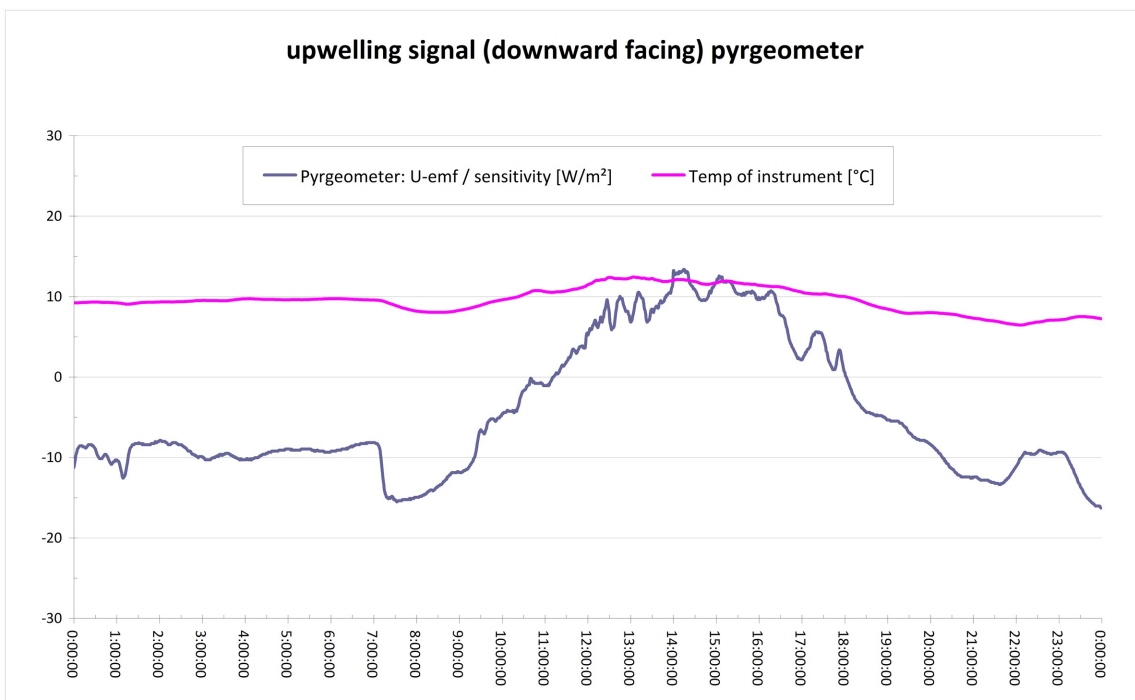

FIGURE B-3. Clear day for the downward facing pyrgometer

It is assumed that when ambient temperature varies, the net far infrared radiation remains roughly the same, independent of ambient temperature. The resulting measured values of the pyrgeometers and pyranometers are shown in columns 4 to 7 in [Table B-1](#) (p. 31). These are indicative figures only, they depend strongly on other circumstances; the pyrgeometer results, of course, change with the sensor temperature. This is indicated in column 8. During the day, the Pt-100 reading may rise due to solar heating, up to 10 degrees above ambient temperature. During the night, the sensor temperature may be lower than the ambient temperature due to far infrared radiative cooling. The latter two effects do not influence the end result of the calculations of sky T and ground T. Therefore, they are not taken into account in the table. In column 4, one might expect to see "0 to -50" for all positions that are showing "0"; in column 5, the "0" values may in reality be "-20 to +20". The resulting sky temperature is indicated in column 9. Under cloudy conditions, this sky temperature is equal to ambient temperature. Under clear conditions, the sky temperature is lower than the ambient temperature.

The ground temperature, in column 10, is assumed to be equal to the ambient temperature. In practice, it may be higher during the day, due to solar heating. Ground temperature may be lower than ambient during the night, due to far infrared radiative cooling. The sky and the ground temperature can be calculated from the measured values of the sensors using formulas [Eq. 9](#) (p. 34) and [Eq. 10](#) (p. 34) below.

$$\mathbf{Sky\ Temperature} = \left[\frac{E\ upper\ CG3}{5.67 \bullet 10^{-8}} \right]^{1/4} \qquad \text{Eq. 9}$$

$$\mathbf{Ground\ Temperature} = \left[\frac{E\ lower\ CG3}{5.67 \bullet 10^{-8}} \right]^{1/4} \qquad 10$$

Appendix C. CNF4 heater ventilator

NOTE:

Whenever the heater is used, the heating may cause errors in the measurement of the sensor temperature. Under most conditions, the accuracy gained by heating will be larger than the errors introduced by heating.

In both the pyranometer and the pyrgeometer, thermal sensors are used, and these sensors, in principle, measure a heat flow. For optimal performance, these sensors should be at thermal equilibrium with the ambient air. Heating the sensor disturbs this equilibrium. The heating causes the zero offset error on the pyranometer (10 W/m² typical), and the temperature measurement error on the sensor (2 degree typical). Therefore, the heater should be used only if absolutely necessary. The pyrgeometer is less sensitive to this. Offset values for the pyrgeometer cannot be determined, and, therefore, are not specified.

C.1 General information

The primary reason for heating the sensor is to avoid the water deposition on the pyrgeometer sensor window and on the pyranometer domes. The water deposition on the pyrgeometer window will ultimately obstruct the far infrared radiation completely. During a rain event, this will probably not cause significant errors, because with an overcast sky, the signal is close to zero anyway. However, the dew deposition is far more significant. Dew deposition will probably take place under conditions with large far infrared irradiation from the pyrgeometer to the clear sky, typically -100 W/m². The dew on the windows of pyrgeometer can cause the -100 W/m² signal to go to zero. In such a case, the heater should be used because the error described above is significantly smaller than the gain obtained by heating the sensor to avoid the dew deposition.

Please refer to the following diagram to determine whether or not the heater should be used.

10 watt power available?	Not available →	DO NOT HEAT
	Available →	Consider the following options ↓
Clock and relay available?	Not Available →	DO NOT HEAT (recommendation)
	Available →	Heat from 1 hour before sunset until 1 hour after sunrise.

The heater power can be controlled using one of the SW12V terminals of the Campbell Scientific data loggers. The heater current drain is approximately 850 mA at 12 VDC (10 W). The ventilator draws additional 5 W of power at 12 VDC. Connect the power ground from the heater to a G terminal close to the SW12V terminal of the data logger (not to an analog ground near the measurement inputs).

The heater power can be controlled by the data logger program. For example, the data logger program can turn on the heater only when the light level falls below 20 W/m² or, if a measurement of air humidity is available, when the dew point of the air falls to within 1 °C of the sensor body temperature.

CAUTION:

Do not use the data logger switched 12 V terminal to simultaneously power the heater and ventilator. Simultaneously powering the heater and ventilator will exceed the current limit of the switched 12 V terminal. If the heater and ventilator need to be used at the same time, connect the CNF4 to the 12 V terminal instead of the switched 12 V terminal and use an external relay to switch the power on and off.

C.2 Attaching the optional CNF4 heater/ventilator unit to CNR4

1. The CNF4 heater/ventilator unit comes with the following: the heater/ventilator, the white solar shield, three pan-head screws with washers, and four flat-head screws as shown in [FIGURE C-1](#) (p. 37).

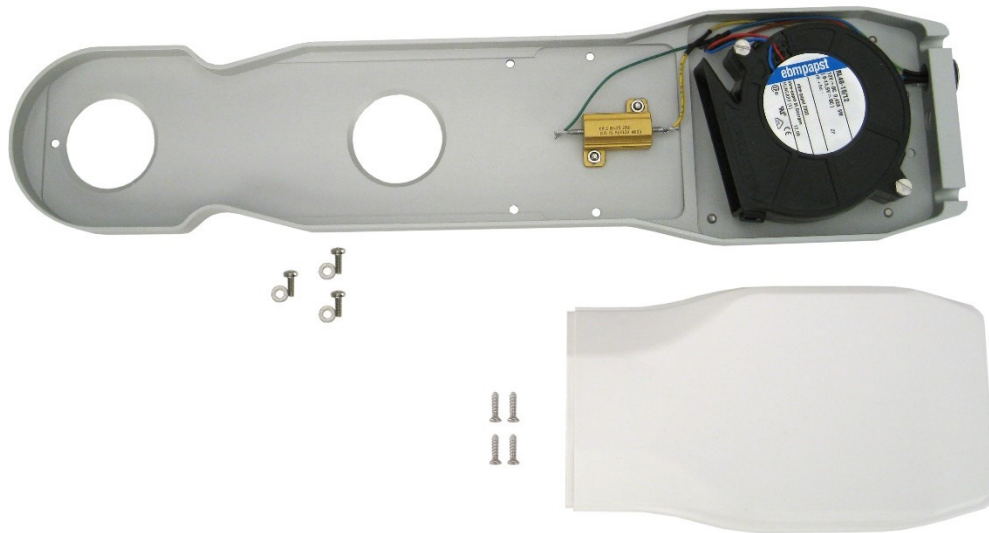

FIGURE C-1. CNF4 package contents

2. Attach the heater/ventilator unit unto the bottom of the CNR4 sensor, using the three pan-head screws and washers, as shown in [FIGURE C-2](#) (p. 38). Make sure that the pyranometer and the pyrgeometer windows are not scratched during the installation.

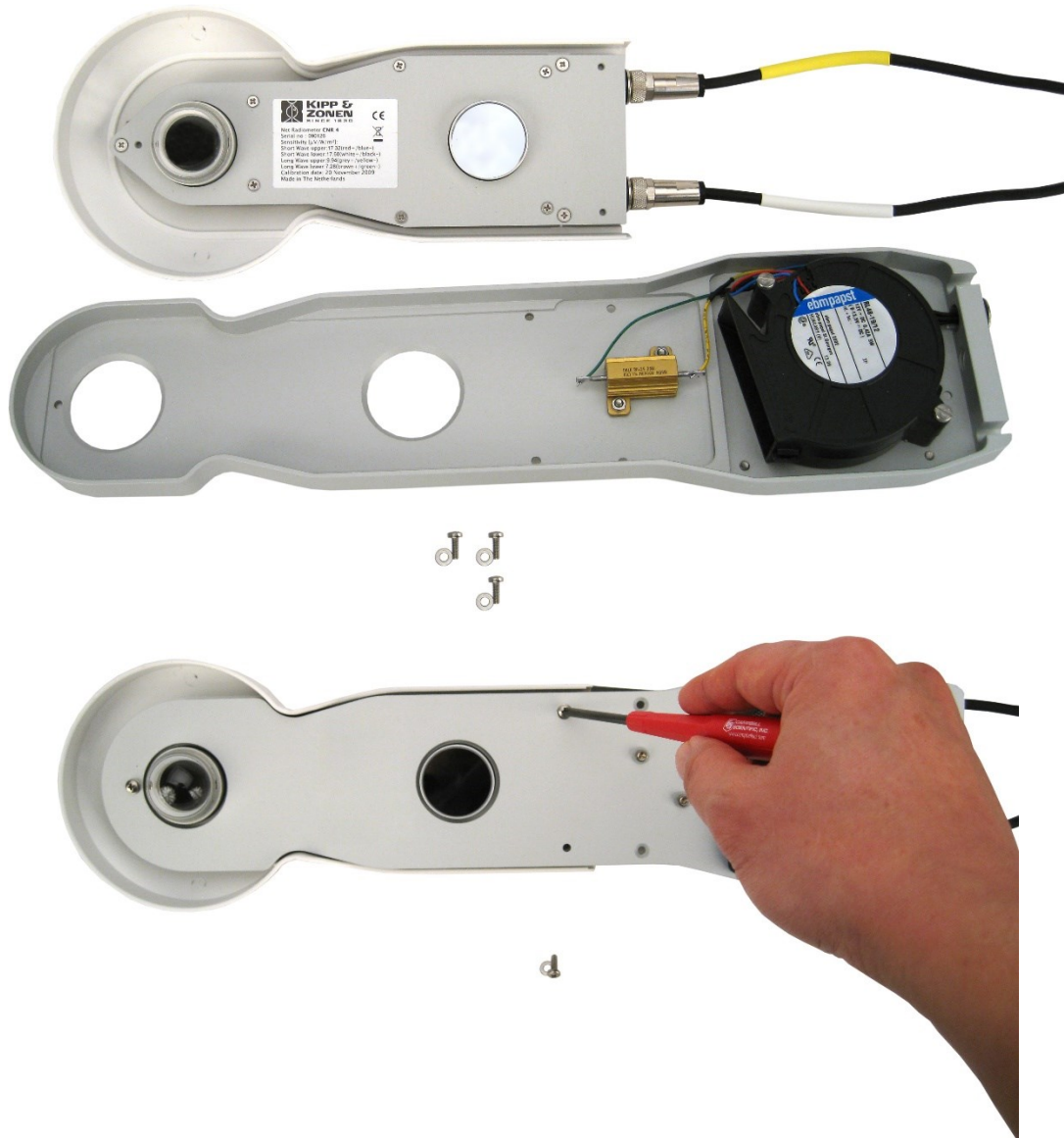

FIGURE C-2. Attaching the CNF4 to CNR4 using pan-head screws and washers

3. Make sure the cables are cleared from the edges of the CNF4, as shown in [FIGURE C-3](#) (p. 39), and place the white solar shield over it. Use the four flat-head screws provided to complete the solar shield installation to the CNF4, as shown in [FIGURE C-4](#) (p. 39) and [FIGURE C-5](#) (p. 40).



FIGURE C-3. Making sure the cables are clear from the edges

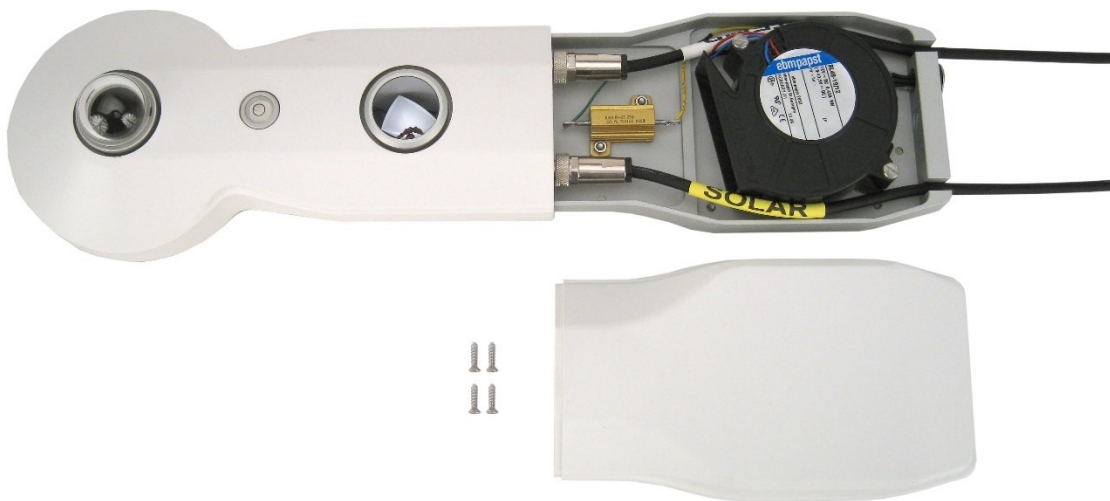

FIGURE C-4. CNF4 solar shield and four flat-head screws



FIGURE C-5. Attaching the solar shield to CNF4 using four flat-head screws

4. Once the CNF4 heater/ventilator unit is attached to the bottom side of the CNR4, the CNF4 will cover the label that contains the serial number and the sensitivity values for the four sensors. Affix the extra label that came with the sensor to the bottom side of the CNF4 anodized aluminium base so that the label is in a visible location. See [FIGURE C-6](#) (p. 40).



FIGURE C-6. Affixing the sensor label to CNF4

5. Connect the heater/ventilator power control cable and the mounting rod to the CNF4, as shown in [FIGURE C-7](#) (p. 40).



FIGURE C-7. Connecting the CNF4 power control cable and the mounting rod

C.3 Wiring

Table C-1 (p. 41) shows the recommended data logger wiring for using the CNR4 sensor with the CNF4 heater/ventilator while making the differential measurement.

NOTE:

Beginning in May of 2016, the CNF4 design was changed from a four-wire connection to an eight-wire connection. The electrical specifications for the heater, ventilator, and tachometer output are identical for the four-wire and eight-wire versions. The only difference between them is the connector layout. The eight-wire version has an added opto-coupler in the tachometer output, which minimizes the voltage drop over the ground line and maximizes the usable cable length. Depending on the data logger that is used with the CNR4-L and the older, four-wire version of the CNF4-L, the tachometer output may not work for 25-m (82-ft) or 50-m (164-ft) cables.

Function	Wire color	Data logger terminal
Pyranometer up signal	Red	U configured for differential input ¹ , DIFF H (differential high, analog-voltage input)
Pyranometer up reference	Blue	U configured for differential input ^{1, 2} , DIFF L (differential low, analog-voltage input) ²
Pyranometer down signal	White	U configured for differential input ¹ , DIFF H (differential high, analog-voltage input)
Pyranometer down reference	Black	U configured for differential input ^{1, 2} , DIFF L (differential low, analog-voltage input) ²
Pyrgeometer up signal	Grey	U configured for differential input ¹ , DIFF H (differential high, analog-voltage input)
Pyrgeometer up reference	Yellow	U configured for differential input ^{1, 2} , DIFF L (differential low, analog-voltage input) ²
Pyrgeometer down signal	Brown	U configured for differential input ¹ , DIFF H (differential high, analog-voltage input)
Pyrgeometer down reference	Green	U configured for differential input ^{1, 2} , DIFF L (differential low, analog-voltage input) ²
Shield	Clear	⏏ (analog ground)

Table C-1: Data logger connections for differential measurement with heater/ventilator control

Function	Wire color	Data logger terminal
Thermistor		
Thermistor signal	White	U configured for single-ended analog input ¹ , SE (single-ended, analog-voltage input)
Thermistor voltage excitation	Red	U configured for voltage excitation ¹ , EX, VX (voltage excitation)
Thermistor signal reference	Black	⊥
Shield	Clear	⊥
CNF4 heater/ventilator		
Ventilator power	Yellow	SW12V
Ventilator ground	Brown	G
Tachometer output	Green	P (pulse), C (control)
Tachometer ground	Grey	G or ⊥
Heater Power	White	SW12V
Heater Power	Black	SW12V
Heater Ground	Red	G
Heater Ground	Blue	G
Shield	Clear	⊥
¹ U terminals are automatically configured by the measurement instruction. ² Jumper to ⊥ with a user-supplied wire.		

Pull back wires for Pt-100 (grey, brown, green, and yellow), which are not in use, and tie them around the TEMP cable using a cable tie or electrical tape to avoid possible damage to the Pt-100, due to electrical short circuit.

CAUTION:

Do not use the data logger switched 12 V to simultaneously power the heater and ventilator. Simultaneously powering the heater and ventilator will exceed the current limit of the switched 12 V terminal. If the heater and ventilator need to be used at the same time, connect

the CNF4 to the 12 V terminal instead of the switched 12 V terminal and use an external relay to switch the power on and off.

C.4 Data logger programming for heater/ventilator control

The data logger program can measure the four radiation outputs and thermistor temperature, read the tachometer, and control the ventilator and heater based on temperature and relative humidity measurements. The tachometer is measured using a `PulseCount()` instruction configured for low-level AC. A sensor such as the EE181 can provide the temperature and relative humidity measurements. The SW12 terminal cannot provide enough amperage for the CNF4. Therefore, the CNR4 should be connected to the 12V terminal. An A21REL-12 can be used to switch 12V to reduce current consumption. An example program that measures the CNR4, controls the heater/ventilator using measurements provided by the EE181 temperature and relative humidity sensor, measures the tachometer, and uses the A21REL-12 to switch 12V power is provided at www.campbellsci.com/downloads/cnr4-cnf4-example-program .

C.5 CNF4 heater/ventilator maintenance

C.5.1 Testing the heater

The optional CNF4 consists of a heater and a ventilator. To check the heater unit, measure the resistance between the two heater wires (green and yellow). The resistance value of the heating resistor inside should be around 15 Ω (cable resistance should add about 0.026 Ω per each foot of cable). An infinite resistance reading indicates the likelihood of a broken wire, or cable.

C.5.2 Testing the ventilator

To check the ventilator, first measure the impedance of the ventilator motor. The value should be around 30 Ω (cable resistance should add about 0.026 Ω per each foot of cable). If the correct resistance value is measured, but the ventilator still malfunctions, it is possible that the ventilator is stalled by an object blocking the fan. Remove the black cover at the bottom side of the ventilator unit, by prying it open with a small flat-head screw driver or by pulling it straight out. Inspect the fan inside for any object that might impede the fan rotation. Upon completing the inspection, put the filter and the cover back in place.

C.5.3 Replacing the filter for the ventilator

The filter needs to be checked for every 6 to 12 months. Remove the black cover at the bottom side of the ventilator by prying it open with a small flat-head screw driver or by pulling it straight out. Inspect the filter for dust and particles that might impede the air flow into the ventilator. The filter can be cleaned with warm clean water, or can be replaced with the new one. You can purchase the replacement filters from Campbell Scientific.

Limited warranty

Products manufactured by Campbell Scientific are warranted by Campbell Scientific to be free from defects in materials and workmanship under normal use and service for twelve months from the date of shipment unless otherwise specified on the corresponding product webpage. See Product Details on the Ordering Information pages at www.campbellsci.com[↗]. Other manufacturer's products, that are resold by Campbell Scientific, are warranted only to the limits extended by the original manufacturer.

Refer to www.campbellsci.com/terms#warranty[↗] for more information.

CAMPBELL SCIENTIFIC EXPRESSLY DISCLAIMS AND EXCLUDES ANY IMPLIED WARRANTIES OF MERCHANTABILITY OR FITNESS FOR A PARTICULAR PURPOSE. Campbell Scientific hereby disclaims, to the fullest extent allowed by applicable law, any and all warranties and conditions with respect to the Products, whether express, implied or statutory, other than those expressly provided herein.

Assistance

Products may not be returned without prior authorization.

Products shipped to Campbell Scientific require a Returned Materials Authorization (RMA) or Repair Reference number and must be clean and uncontaminated by harmful substances, such as hazardous materials, chemicals, insects, and pests. Please complete the required forms prior to shipping equipment.

Campbell Scientific regional offices handle repairs for customers within their territories. Please see the back page for the Global Sales and Support Network or visit www.campbellsci.com/contact  to determine which Campbell Scientific office serves your country.

To obtain a Returned Materials Authorization or Repair Reference number, contact your CAMPBELL SCIENTIFIC regional office. Please write the issued number clearly on the outside of the shipping container and ship as directed.

For all returns, the customer must provide a "Statement of Product Cleanliness and Decontamination" or "Declaration of Hazardous Material and Decontamination" form and comply with the requirements specified in it. The form is available from your CAMPBELL SCIENTIFIC regional office. Campbell Scientific is unable to process any returns until we receive this statement. If the statement is not received within three days of product receipt or is incomplete, the product will be returned to the customer at the customer's expense. Campbell Scientific reserves the right to refuse service on products that were exposed to contaminants that may cause health or safety concerns for our employees.

Safety

DANGER — MANY HAZARDS ARE ASSOCIATED WITH INSTALLING, USING, MAINTAINING, AND WORKING ON OR AROUND TRIPODS, TOWERS, AND ANY ATTACHMENTS TO TRIPODS AND TOWERS SUCH AS SENSORS, CROSSARMS, ENCLOSURES, ANTENNAS, ETC. FAILURE TO PROPERLY AND COMPLETELY ASSEMBLE, INSTALL, OPERATE, USE, AND MAINTAIN TRIPODS, TOWERS, AND ATTACHMENTS, AND FAILURE TO HEED WARNINGS, INCREASES THE RISK OF DEATH, ACCIDENT, SERIOUS INJURY, PROPERTY DAMAGE, AND PRODUCT FAILURE. TAKE ALL REASONABLE PRECAUTIONS TO AVOID THESE HAZARDS. CHECK WITH YOUR ORGANIZATION'S SAFETY COORDINATOR (OR POLICY) FOR PROCEDURES AND REQUIRED PROTECTIVE EQUIPMENT PRIOR TO PERFORMING ANY WORK.

Use tripods, towers, and attachments to tripods and towers only for purposes for which they are designed. Do not exceed design limits. Be familiar and comply with all instructions provided in product manuals. Manuals are available at www.campbellsci.com. You are responsible for conformance with governing codes and regulations, including safety regulations, and the integrity and location of structures or land to which towers, tripods, and any attachments are attached. Installation sites should be evaluated and approved by a qualified engineer. If questions or concerns arise regarding installation, use, or maintenance of tripods, towers, attachments, or electrical connections, consult with a licensed and qualified engineer or electrician.

General

- Protect from over-voltage.
- Protect electrical equipment from water.
- Protect from electrostatic discharge (ESD).
- Protect from lightning.
- Prior to performing site or installation work, obtain required approvals and permits. Comply with all governing structure-height regulations.
- Use only qualified personnel for installation, use, and maintenance of tripods and towers, and any attachments to tripods and towers. The use of licensed and qualified contractors is highly recommended.
- Read all applicable instructions carefully and understand procedures thoroughly before beginning work.
- Wear a **hardhat** and **eye protection**, and take **other appropriate safety precautions** while working on or around tripods and towers.
- **Do not climb** tripods or towers at any time, and prohibit climbing by other persons. Take reasonable precautions to secure tripod and tower sites from trespassers.
- Use only manufacturer recommended parts, materials, and tools.

Utility and Electrical

- **You can be killed** or sustain serious bodily injury if the tripod, tower, or attachments you are installing, constructing, using, or maintaining, or a tool, stake, or anchor, come in **contact with overhead or underground utility lines**.
- Maintain a distance of at least one-and-one-half times structure height, 6 meters (20 feet), or the distance required by applicable law, **whichever is greater**, between overhead utility lines and the structure (tripod, tower, attachments, or tools).
- Prior to performing site or installation work, inform all utility companies and have all underground utilities marked.
- Comply with all electrical codes. Electrical equipment and related grounding devices should be installed by a licensed and qualified electrician.
- Only use power sources approved for use in the country of installation to power Campbell Scientific devices.

Elevated Work and Weather

- Exercise extreme caution when performing elevated work.
- Use appropriate equipment and safety practices.
- During installation and maintenance, keep tower and tripod sites clear of un-trained or non-essential personnel. Take precautions to prevent elevated tools and objects from dropping.
- Do not perform any work in inclement weather, including wind, rain, snow, lightning, etc.

Maintenance

- Periodically (at least yearly) check for wear and damage, including corrosion, stress cracks, frayed cables, loose cable clamps, cable tightness, etc. and take necessary corrective actions.
- Periodically (at least yearly) check electrical ground connections.

Internal Battery

- Be aware of fire, explosion, and severe-burn hazards.
- Misuse or improper installation of the internal lithium battery can cause severe injury.
- Do not recharge, disassemble, heat above 100 °C (212 °F), solder directly to the cell, incinerate, or expose contents to water. Dispose of spent batteries properly.

WHILE EVERY ATTEMPT IS MADE TO EMBODY THE HIGHEST DEGREE OF SAFETY IN ALL CAMPBELL SCIENTIFIC PRODUCTS, THE CUSTOMER ASSUMES ALL RISK FROM ANY INJURY RESULTING FROM IMPROPER INSTALLATION, USE, OR MAINTENANCE OF TRIPODS, TOWERS, OR ATTACHMENTS TO TRIPODS AND TOWERS SUCH AS SENSORS, CROSSARMS, ENCLOSURES, ANTENNAS, ETC.



Global Sales & Support Network

A worldwide network to help meet your needs



Campbell Scientific Regional Offices

Australia

Location: Garbutt, QLD Australia
Phone: 61.7.4401.7700
Email: info@campbellsci.com.au
Website: www.campbellsci.com.au

Brazil

Location: São Paulo, SP Brazil
Phone: 11.3732.3399
Email: vendas@campbellsci.com.br
Website: www.campbellsci.com.br

Canada

Location: Edmonton, AB Canada
Phone: 780.454.2505
Email: dataloggers@campbellsci.ca
Website: www.campbellsci.ca

China

Location: Beijing, P. R. China
Phone: 86.10.6561.0080
Email: info@campbellsci.com.cn
Website: www.campbellsci.com.cn

Costa Rica

Location: San Pedro, Costa Rica
Phone: 506.2280.1564
Email: info@campbellsci.com
Website: www.campbellsci.com

France

Location: Vincennes, France
Phone: 0033.0.1.56.45.15.20
Email: info@campbellsci.fr
Website: www.campbellsci.fr

Germany

Location: Bremen, Germany
Phone: 49.0.421.460974.0
Email: info@campbellsci.de
Website: www.campbellsci.de

India

Location: New Delhi, DL India
Phone: 91.11.46500481.482
Email: info@campbellsci.in
Website: www.campbellsci.in

South Africa

Location: Stellenbosch, South Africa
Phone: 27.21.8809960
Email: sales@campbellsci.co.za
Website: www.campbellsci.co.za

Spain

Location: Barcelona, Spain
Phone: 34.93.2323938
Email: info@campbellsci.es
Website: www.campbellsci.es

Thailand

Location: Bangkok, Thailand
Phone: 66.2.719.3399
Email: info@campbellsci.asia
Website: www.campbellsci.asia

UK

Location: Shepshed, Loughborough, UK
Phone: 44.0.1509.601141
Email: sales@campbellsci.co.uk
Website: www.campbellsci.co.uk

USA

Location: Logan, UT USA
Phone: 435.227.9120
Email: info@campbellsci.com
Website: www.campbellsci.com